



ECO EPN 2000 II Set Security short plate

Product information



■ SYSTEM TECHNOLOGY FOR THE DOOR

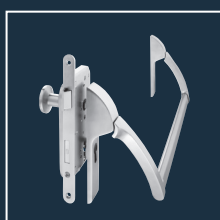
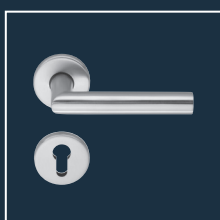
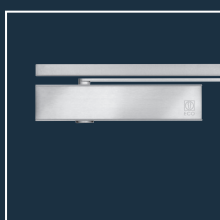

Product characteristics		
Mode of operation	Touchbar Pushbar	■ -
Finish	Stainless steel	■
	Aluminium F1 coated	■
Fixing axis	1.000 mm	■
	1.250 mm	■
DIN left / right usable		■
Suitable for the use on fire- and smoke protection doors	F	■
Tested acc. to EN / DIN	EN 1125	■

■ Yes - No



B

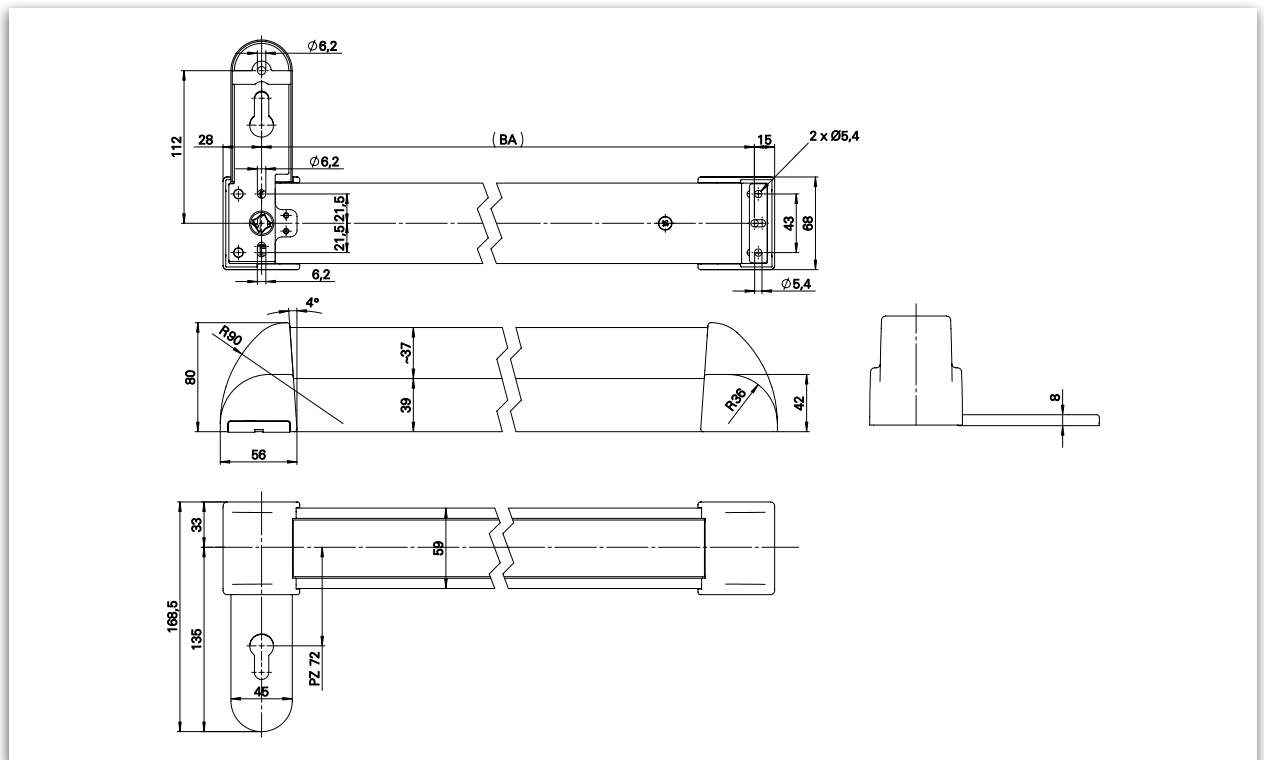

EPN 2000 II Dimensioning: B: Screw-through version

Description

EPN 2000 II Security short plate handle / Touchbar

This execution of the touch plate of the EPN 2000 II has been especially designed for the use with security handles on short plate as counter hardware. The norm and drillhole distances for security handles on short plate have been taken into consideration.

- Tested acc. to **EN 1125, EN 1634**
- Can be used according to **EN 1125** only in combination with tested lock and door hardware

- Tested acc. to **EN 1906 / DIN 18257**
- Suitable for the use on fire- and smoke control doors according testing
- Screw-through version
- DIN left / right usable
- Finish:
Stainless steel
Aluminium F1 (silver coated)*

Set EPN 2000 II with Sec. short plate counter handle





Set consists of:



- **EPN 2000 II ER** (also available in aluminium, F1 silver coated)*
- **Security short plate counter handle with OGL - friction bearing technology**
 Counter handle lever D-110 (PZ or ZA)
 Counter handle knob K-130 (PZ or ZA)

Accessories

- Screw bag set (please mention door thickness)
- Spindle has to be ordered separately



Set EPN 2000 II Stainless steel	Fixing axis	DIN left / right	Rotation angle	EPN 2000 II	Special handle PZ-72 / 14 mm	
					 D-110	 K-130
Screw-through version	1.000 mm	DIN left	45°	106706024600221	106940024600010	106942024600010
		DIN right		106706024600222		
	1.250 mm	DIN left		106706044600221		
		DIN right		106706044600222		

Set EPN 2000 II Stainless steel	Fixing axis	DIN left / right	Rotation angle	EPN 2000 II	Special handle ZA-72 / 14 mm	
					 D-110	 K-130
Screw-through version	1.000 mm	DIN left	45°	106706024600221	106940524600010	106942524600010
		DIN right		106706024600222		
	1.250 mm	DIN left		106706044600221		
		DIN right		106706044600222		

Further versions and handle types on request.

Please see our notes

 *Manufacturing of special lengths on request and against surcharge possible.

ECO Schulte GmbH & Co. KG
Iserlohner Landstraße 89
D - 58706 Menden

Telefon: +49 2373/9276-0
Fax: +49 2373/9276-40

info@eco-schulte.de
www.eco-schulte.de

© ECO Schulte GmbH & Co. KG - Änderungen vorbehalten
© ECO Schulte GmbH & Co. KG - Subject to change