



ECO EPN 2000 II Set Security long plate

Product information



■ SYSTEM TECHNOLOGY FOR THE DOOR

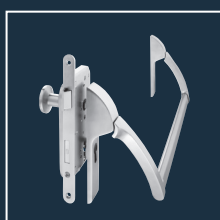
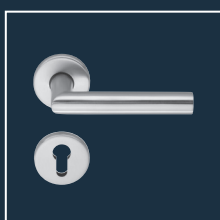

Product characteristics		
Mode of operation	Touchbar Pushbar	■ -
Finish	Stainless steel	■
	Aluminium F1 coated	■
Fixing axis	1.000 mm	■
	1.250 mm	■
DIN left / right usable		■
Suitable for the use on fire- and smoke protection doors	F	■
Tested acc. to EN / DIN	EN 1125	■

■ Yes - No



B

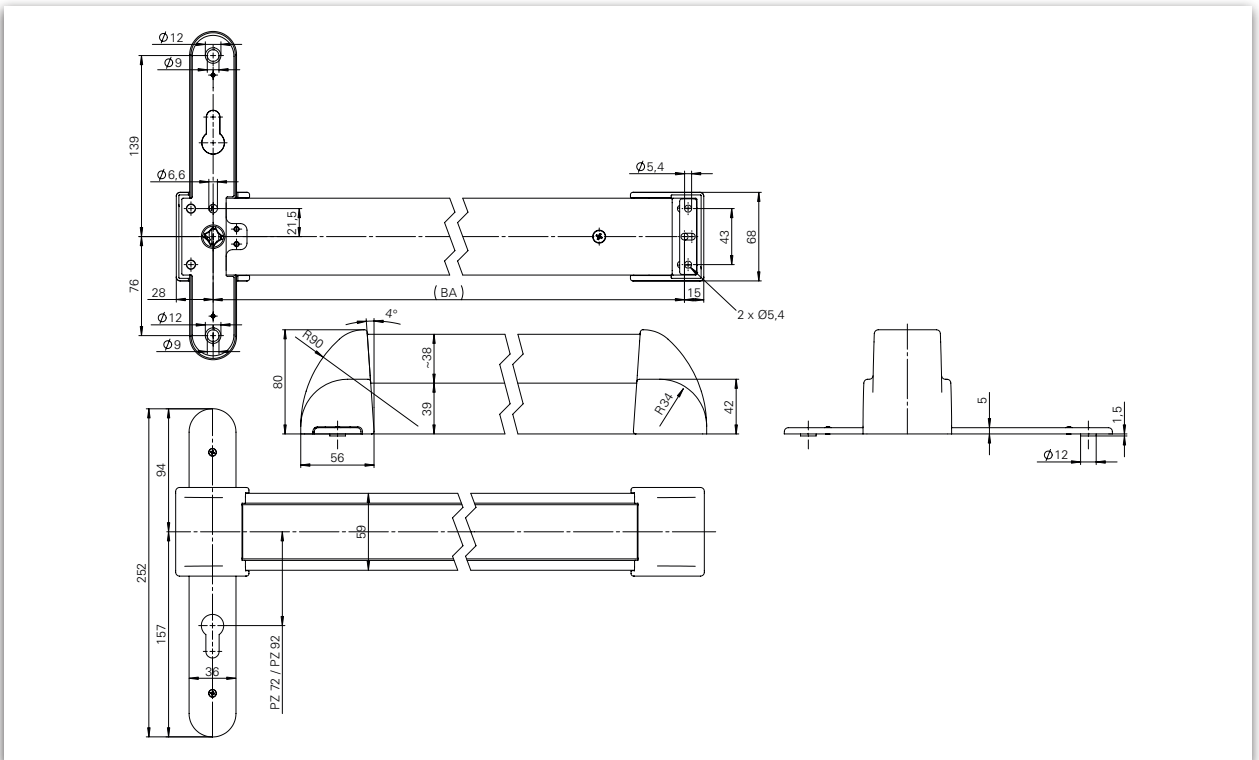

EPN 2000 II Dimensioning: B: Screw-through version

Description

EPN 2000 II Security long plate handle / Touchbar

This execution of the touch plate of the EPN 2000 II has been especially designed for the use with security handles on long plate as counter hardware. The norm and drillhole distances for security handles on long plate have been taken into consideration.

- Tested acc. to **EN 1125, EN 1634**
- Can be used according to **EN 1125** only in combination with tested lock and door hardware

- Tested according to **EN 1906 / DIN 18257**
- Suitable for the use on fire- and smoke control doors according testing
- Screw-through version
- DIN left / right usable
- Finish:
Stainless steel
Aluminium F1 (silver coated)*

Set EPN 2000 II with Sec. long plate counter handle





Set consists of:



- **EPN 2000 II ER** (also available in aluminium, F1 silver coated)*
- **Security long plate counter handle with OGL - friction bearing technology**
Counter handle lever D-110 (PZ or ZA)
Counter handle knob K-130 (PZ or ZA)

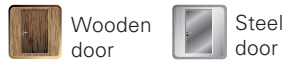

Accessories



- Screw bag set (please mention door thickness)
- Spindle has to be ordered separately



Set EPN 2000 II Stainless steel	Fixing axis	DIN left / right	Rotation angle	EPN 2000 II	Special handle PZ-72 / 14 mm	
					 D-110	 K-130
Screw-through version	1.000 mm	DIN left	45°	106706024601221	106940004600010	106942004600010
		DIN right		106706024601222		
	1.250 mm	DIN left		106706044601221		
		DIN right		106706044601222		

Set EPN 2000 II Stainless steel	Fixing axis	DIN left / right	Rotation angle	EPN 2000 II	Special handle ZA-72 / 14 mm	
					 D-110	 K-130
Screw-through version	1.000 mm	DIN left	45°	106706024601221	106940504600010	106942504600010
		DIN right		106706024601222		
	1.250 mm	DIN left		106706044601221		
		DIN right		106706044601222		

Set EPN 2000 II Stainless steel	Fixing axis	DIN left / right	Rotation angle	EPN 2000 II	Special handle PZ-92 / 14 mm	
					 D-110	 K-130
Screw-through version	1.000 mm	DIN left	45°	106706024602221	106940014600010	106942014600010
		DIN right		106706024602222		
	1.250 mm	DIN left		106706044602221		
		DIN right		106706044602222		

Set EPN 2000 II Stainless steel	Fixing axis	DIN left / right	Rotation angle	EPN 2000 II	Special handle ZA-92 / 14 mm	
					 D-110	 K-130
Screw-through version	1.000 mm	DIN left	45°	106706024602221	106940514600010	106942514600010
		DIN right		106706024602222		
	1.250 mm	DIN left		106706044602221		
		DIN right		106706044602222		

Further versions and handle types on request.

Please see our notes

*Manufacturing of special lengths on request and against surcharge possible.



ECO Schulte GmbH & Co. KG
Iserlohner Landstraße 89
D - 58706 Menden

Telefon: +49 2373/9276-0
Fax: +49 2373/9276-40

info@eco-schulte.de
www.eco-schulte.de

© ECO Schulte GmbH & Co. KG - Änderungen vorbehalten
© ECO Schulte GmbH & Co. KG - Subject to change