



ECO EPN 900 IV Set Short plate

Product information



■ SYSTEM TECHNOLOGY FOR THE DOOR

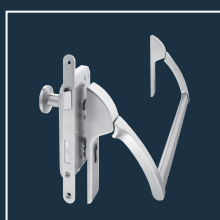
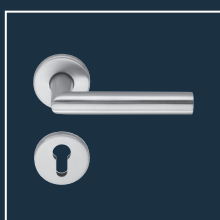

Product characteristics

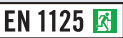
Mode of operation	Touchbar Pushbar	- ■
Finish	Stainless steel	■
	Alu. F1 coated	■
	Colour coated	■
Grip tube	900*	■
	1.150*	■
	1.500*	□
Lock type	PZ-72	■
	PZ-92	■
	RZ-74	■
	RZ-94	■
	UG (blind)	■
DIN left / right usable		■
Suitable for the use on fire- and smoke control doors		■
Tested acc. to DIN / EN		■

■ Yes - No □ Option

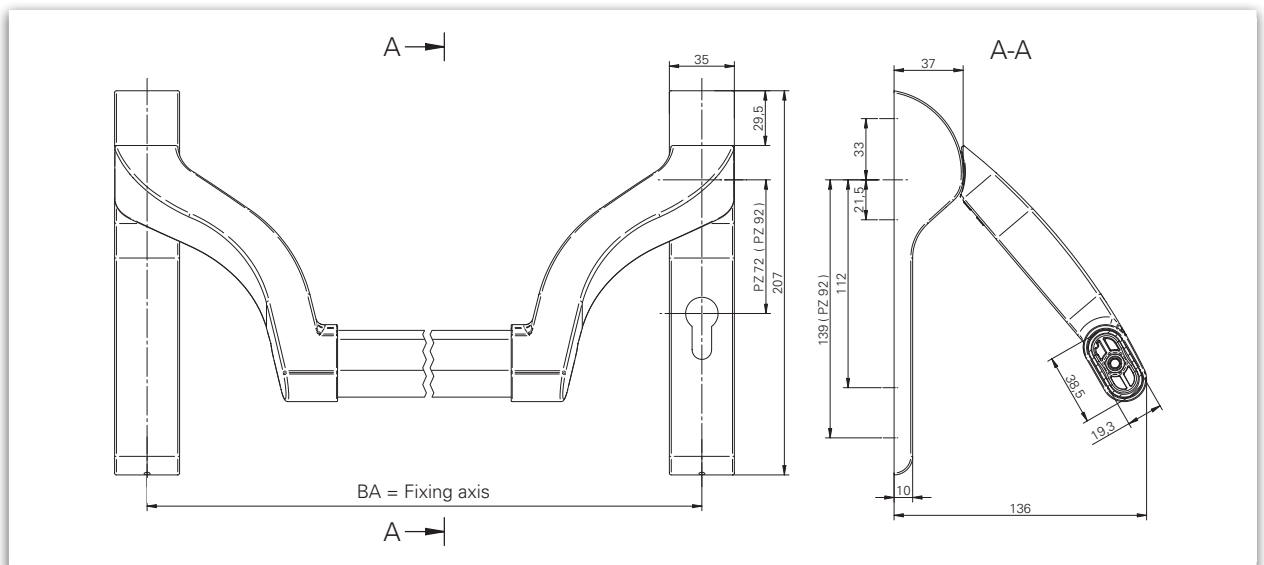
EPN 900 IV Set ■ Short plate

Dimensioning: EPN 900 IV with short plate counter handle

Description
EPN 900 IV Short plate handle / Pushbar

The arms are highly cranked and enable the use of electronic key cylinders.

This execution of tube for EPN 900 IV has especially been designed for the use with short plate handles as counter hardware. The norm and drillhole distances for short plate handles as counter hardware have been taken into consideration.

- Tested acc. to **EN 1125, EN 1634, EN 1191**
- Can be used according to **EN 1125** only in combination with tested lock and door hardware
- Suitable for the use on fire- and smoke control doors according testing
- DIN left / right usable

- Arms highly cranked, suitable in particular for electronic key cylinders and short PZ distances.
- Large, stable grip tube (vandalism)
- High-strength screwing of arm and tube
- Finish:
 - Stainless steel satin brushed
 - Silver (F1)* coated (on basis of EPN 900 IV Stainless steel)
 - Steel zinc-plated and silver (F1)* coated
- Gear unit: steel zinc-plated

Set EPN 900 IV with Short plate counter handle





Set consists of:

- **EPN 900 IV ER** (also available in aluminium, F1 silver coated)*
- **Short plate counter handle with OGL – friction bearing technology**
Counter handle lever D-110 (PZ)
Counter handle knob K-130 (PZ)

Accessories

- Screw bag set (please mention door thickness)
- Grip tube (see length-chart)
- Spindle has to be ordered separately



Set EPN 900 IV Stainless steel	Turning angle	EPN 900 IV	Counter handle PZ-72	
			 D-110	 K-130
PZ-72	45°	1069a1454600080	106910004600902	106915004600902

Further versions and handle types on request.

Accessories



Grip tube ER	Fixing axis (BA) max.	Article number
900 mm	1.067 mm	109506604600070
1.150 mm	1.317 mm	109506614600070
1.500 mm	1.669 mm	109506644600070

The grip tube has to be ordered separately.

Please see our notes

ECO Schulte GmbH & Co. KG
Iserlohner Landstraße 89
D - 58706 Menden

Telefon: +49 2373/9276-0
Fax: +49 2373/9276-40

info@eco-schulte.de
www.eco-schulte.de

© ECO Schulte GmbH & Co. KG - Änderungen vorbehalten
© ECO Schulte GmbH & Co. KG - Subject to change