

PRODUCT INFORMATION

ECO HORIZON PROJECT HINGES
OBN-18-4141/160-R

■ SYSTEM TECHNOLOGY FOR THE DOOR

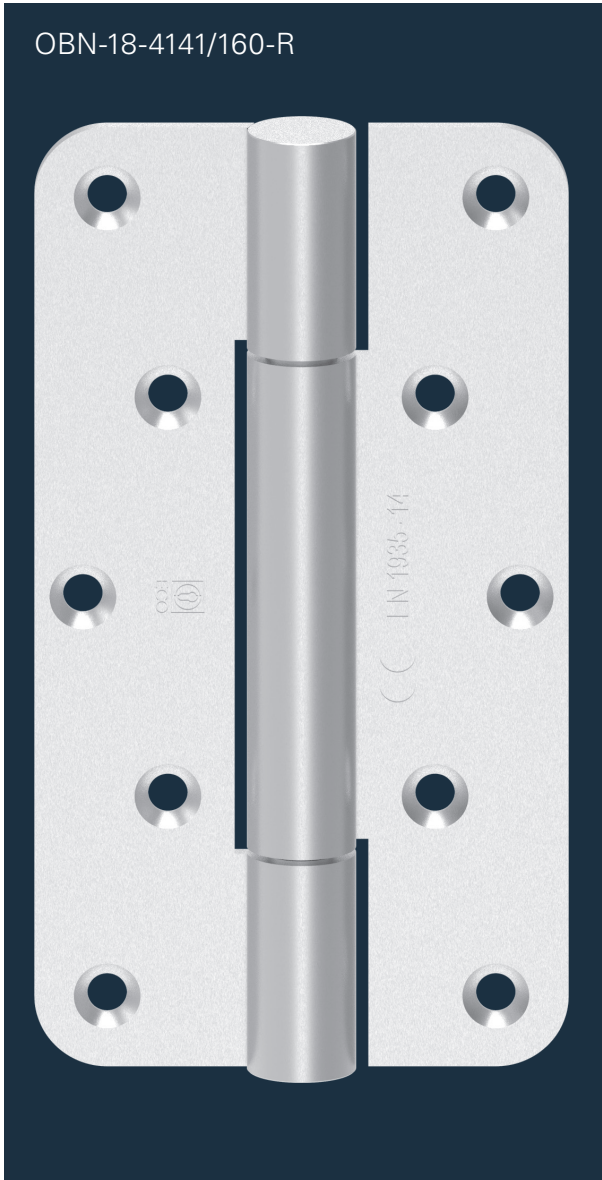



Product characteristics		
Size	160 mm	
Ø Barrel diameter	18 mm	
Material thickness	3 mm	
Screws	5 x 50 mm	
DIN left / DIN right	■	
Milling diameter	24 mm	
Milling length	160 mm	
Milling depth	3 mm	
Door types	rebated	-
	unrebated	■
Frame types	Wood	■
Suitable for fire doors	F	■
Loading capacity class 14 (door weight)	EN 1935 CE	■
	acc. to Norm	160 kg
	ECO loading capacity	200 kg
Material	Stainless steel (ER)	■
Finishes	ER polished	□
	PVD coating (brass)	□
	Coating in RAL colours	□

■ Yes - No □ On request

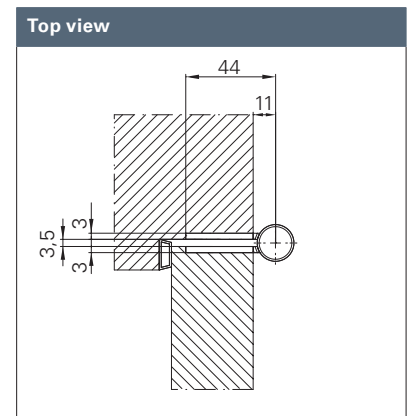
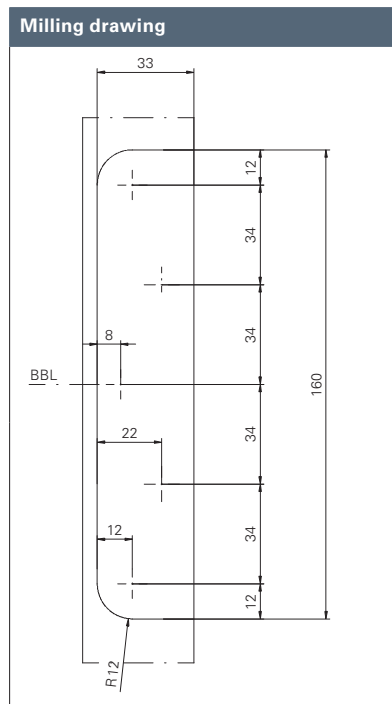
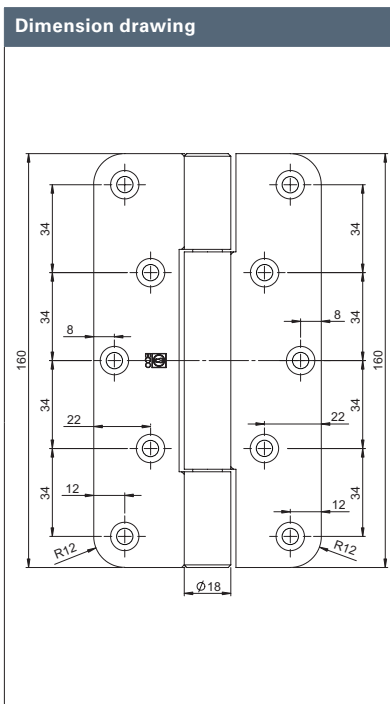

optionally available as version with lifting lugs

PRODUCT FAMILY ■ FOR MORTISE FLUSH DOOR 3D HINGE

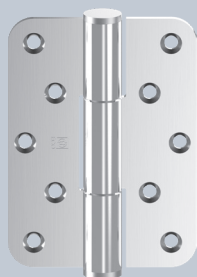

OBN-18-4141/120-R.ER round

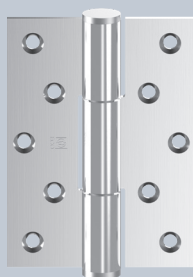

OBN-18-4141/120-E.ER edged



Description

ECO Horizon project hinge OBN-18-4141/160-R round

- For unrebated doors on upright standing pillars
- Inner, firmly rotating axis
- Wear and maintenance-free ball bearing technology
- Suitable for fire doors
- Can be used DIN left / DIN right without modification
- EN 1935: Class 14 / 160 kg

F **EN 1935** **CE** **ER**  Wooden door

OBN-18-4141/160-R round for mortise flush door 3D hinge	Dimensions	Art-No.
OBN-18-4141/160-R.ER	Ø 18 x 160 mm	5030007475
OBN-18-4141/160-R.St.Ni	Ø 18 x 160 mm	on request
OBN-18-4141/160-R.St.Zk	Ø 18 x 160 mm	on request

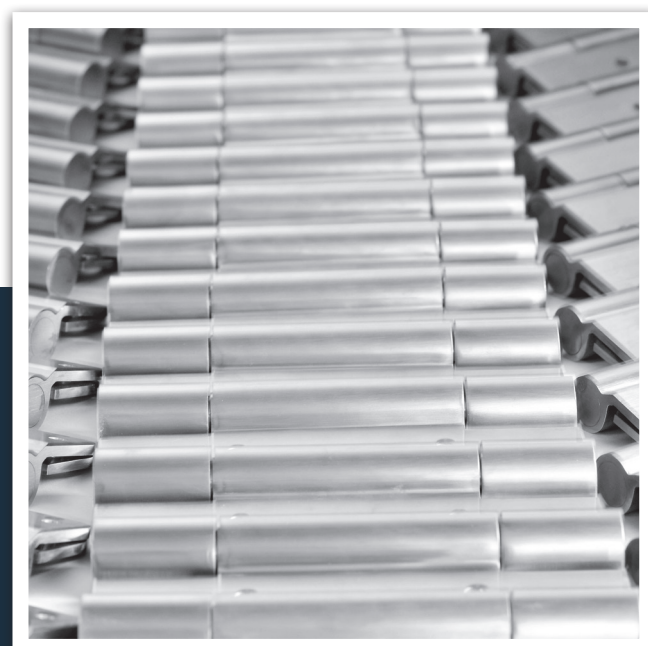

ECO **Schulte GmbH & Co. KG**

Iserlohner Landstraße 89

D-58706 Menden

Telephone +49 2373 9276 - 0

Telefax +49 2373 9276 - 40

info@eco-schulte.de

www.eco-schulte.de

■ SYSTEM TECHNOLOGY FOR THE DOOR

