



PRODUKTINFORMATION

ECO ABDECKWINKEL
OBX-3096

■ SYSTEMTECHNIK FÜR DIE TÜR





Abbildung: Abdeckwinkel OBX-3096



Bemaßung: Abdeckwinkel OBX-3096

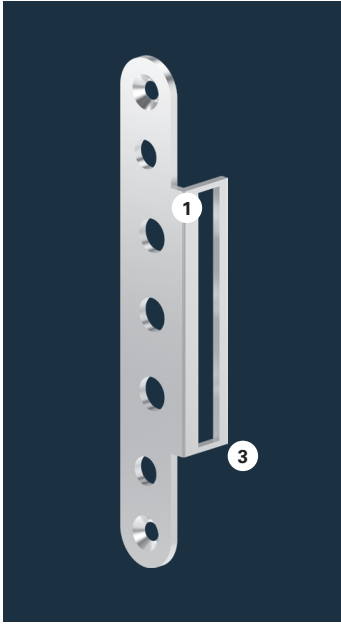
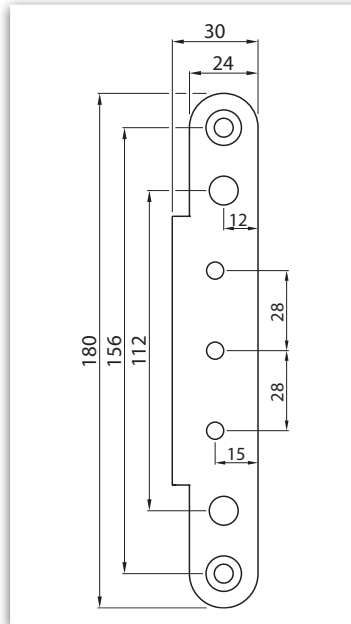
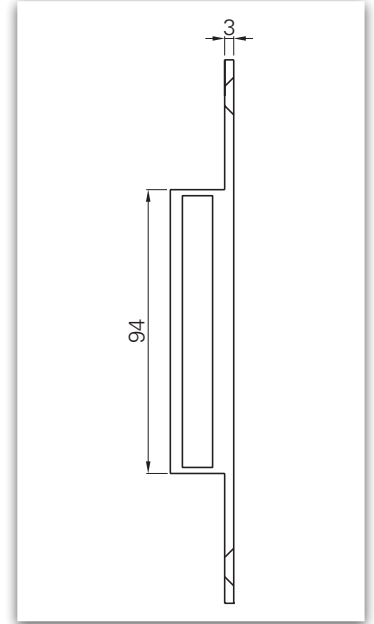

Bemaßung: Abdeckwinkel OBX-3096

OBX-3096	Material	Winkel · Abschluss	Art-Nr
OBX-3096.ER	ER	Eckig - Eckig	5030016571



Abbildung: Abdeckwinkel OBX-3097



Bemaßung: Abdeckwinkel OBX-3097

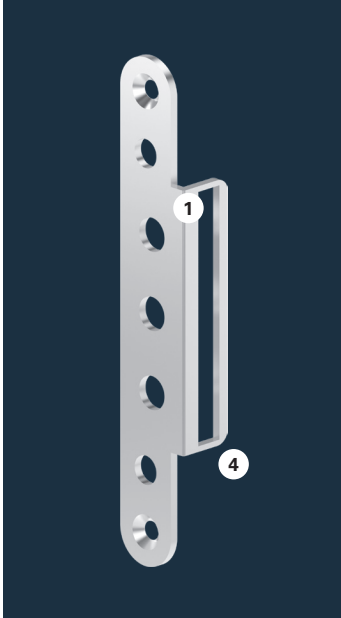
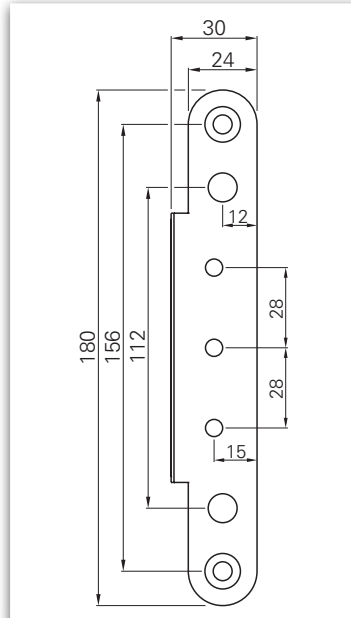
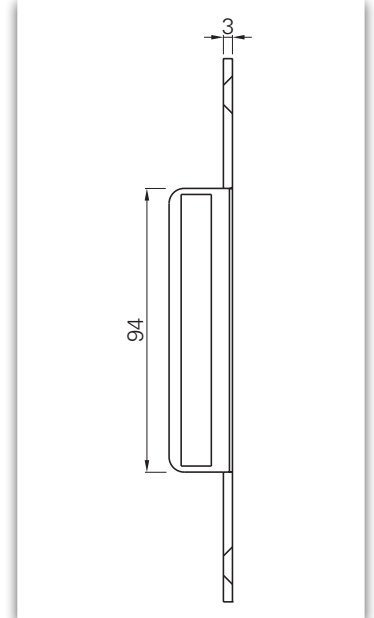

Bemaßung: Abdeckwinkel OBX-3097

OBX-3097	Material	Winkel · Abschluss	Art-Nr
OBX-3097.ER	ER	Eckig - Rund	5030016578

① mit eckigem Winkel

② mit rundem Winkel

③ und eckigem Abschluss

④ und rundem Abschluss

OBX-Abdeckwinkel für Aufnahmelemente



Abbildung: Abdeckwinkel OBX-3098

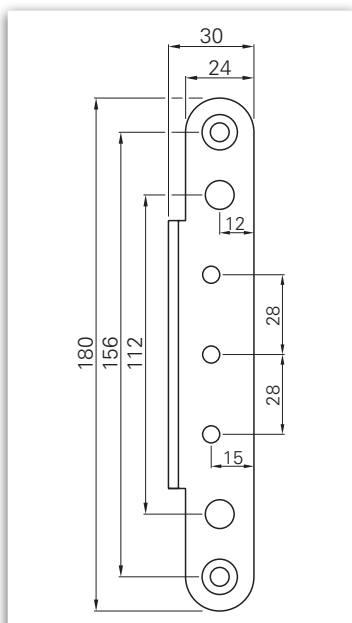

Bemaßung: Abdeckwinkel OBX-3098

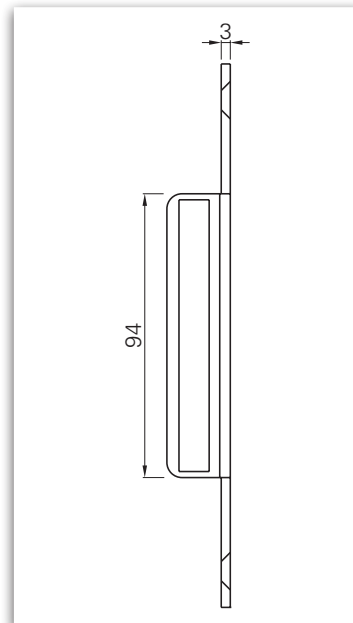

Bemaßung: Abdeckwinkel OBX-3098

OBX-3098	Material	Winkel · Abschluss	Art-Nr
OBX-3098.ER	ER	Rund - Rund	5030016578



Abbildung: Abdeckwinkel OBX-3099



Bemaßung: Abdeckwinkel OBX-3099

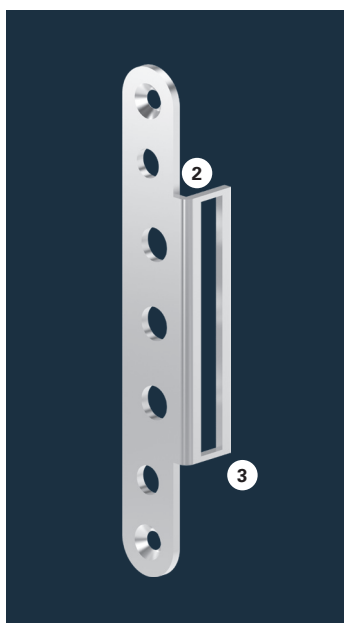
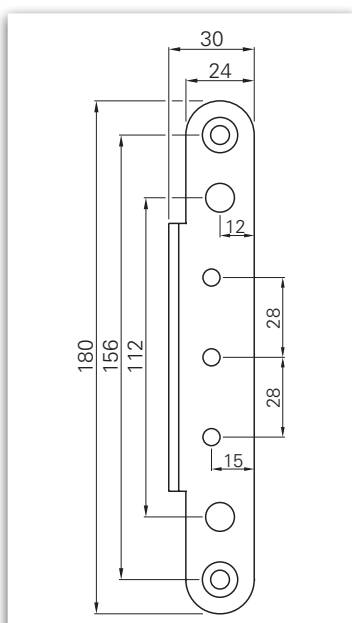
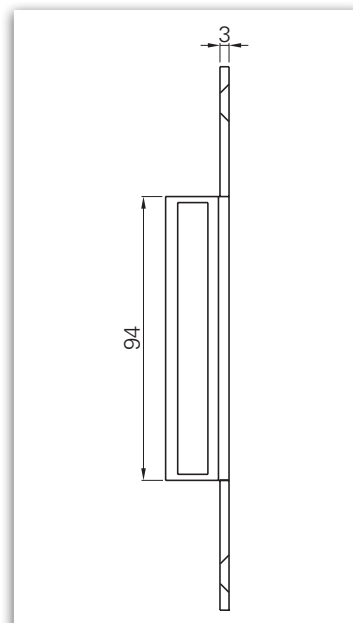

Bemaßung: Abdeckwinkel OBX-3099

OBX-3099	Material	Winkel · Abschluss	Art-Nr
OBX-3099.ER	ER	Rund - Eckig	5030013490

- ① mit eckigem Winkel
- ② mit rundem Winkel

- ③ und eckigem Abschluss
- ④ und rundem Abschluss

ECO Schulte GmbH & Co. KG

Iserlohner Landstraße 89

D-58706 Menden

Telefon +49 2373 9276 - 0

Telefax +49 2373 9276 - 40

info@eco-schulte.de

www.eco-schulte.de

■ SYSTEMTECHNIK FÜR DIE TÜR

